



100% PURE SINE WAVE HOME INVERTER

# USER'S MANUAL SOLAR INVERTER

2KW~5.5KW

Appliances



PC



TV



Air-  
conditioning



Fridge



Washing  
machine

# Table of Contents

<b>ABOUT THIS MANUAL</b> .....	1
Purpose .....	1
Scope .....	1
<b>SAFETY INSTRUCTIONS</b> .....	1
<b>INTRODUCTION</b> .....	2
Features.....	2
Basic System Architecture.....	2
Product Overview.....	3
<b>INSTALLATION</b> .....	4
Unpacking and Inspection.....	4
Preparation.....	4
Mounting the Unit.....	4
Battery Connection.....	5
AC Input/ Output Connection.....	7
PV Connection .....	8
Final Assembly.....	10
Communication Connection.....	10
<b>OPERATION</b> .....	11
Power ON/OFF.....	11
Operation and Display Panel.....	11
LCD Display Icons.....	12
LCD Setting.....	14
Fault Reference Code.....	20
Warning Indicator.....	22
Operating Mode Description.....	23
Display Setting.....	24
<b>SPECIFICATIONS</b> .....	24
Table 1 Line Mode Specifications.....	24
Table 2 Inverter Mode Specifications.....	25
Table 3 Charge Mode Specifications.....	26
Table 4 General Specifications.....	27
<b>TROUBLE SHOOTING</b> .....	28
<b>Appendix: Approximate Back-up Time Table</b> .....	29

## ABOUT THIS MANUAL

### Purpose

This manual describes the assembly, installation, operation and troubleshooting of this unit. Please read this manual carefully before installations and operations. Keep this manual for future reference.

### Scope

This manual provides safety and installation guidelines as well as information on tools and wiring.

### The following cases are not within the scope of warranty

1. Out of warranty.
2. Series number was changed or lost.
3. Battery capacity was declined or external damaged.
4. Inverter was damaged caused of transport shift, remissness, ect external factor
5. Inverter was damaged caused of irresistible natural disasters.
6. Not in accordance with the electrical power supply conditions or operate environment caused damage.

## SAFETY INSTRUCTIONS



**WARNING: This chapter contains important safety and operating instructions. Read and keep this manual for future reference.**

1. Before using the unit, read all instructions and cautionary markings on the unit the batteries and all appropriate sections of this manual.
2. **CAUTION** --To reduce risk of injury, charge only deep-cycle lead acid type rechargeable batteries. Other types of batteries may burst, causing personal injury and damage.
3. Do not disassemble the unit. Take it to a qualified service center when service or repair is required. Incorrect re-assembly may result in a risk of electric shock or fire.
4. To reduce risk of electric shock, disconnect all wirings before attempting any maintenance or cleaning. Turning off the unit will not reduce this risk.
5. **CAUTION** --Only qualified personnel can install this device with battery.
6. **NEVER** charge a frozen battery.
7. For optimum operation of this inverter/charger, please follow required spec to select appropriate cable size. It' s very important to correctly operate this inverter/charger.
8. Be very cautious when working with metal tools on or around batteries. A potential risk exists to drop a tool to spark or short circuit batteries or other electrical parts and could cause an explosion.
9. Please strictly follow installation procedure when you want to disconnect AC or DC terminals. Please refer to INSTALLATION section of this manual for the details.
10. Fuses (1 piece of 150A, 63VDC for 2KW~ 5.5KW) are provided as over-current protection for the battery supply.
11. GROUNDING INSTRUCTIONS- This inverter/charger should be connected to a permanent grounded wiring system. Be sure to comply with local requirements and regulation to install this inverter.
12. NEVER cause AC output and DC input short circuited. Do NOT connect to the mains when DC input short circuits.
13. **Warning!!** Only qualified service persons are able to service this device. If errors still persist after following troubleshooting table, please send this inverter/charger back to local dealer or service center for maintenance.

## INTRODUCTION

This is a multi-function inverter/charger, combining functions of inverter, solar charger and battery charger to offer uninterruptible power support with portable size. Its comprehensive LCD display offers user-configurable and easy-accessible button operation such as battery charging current, AC/solar charger priority, and acceptable input voltage based on different applications.

## Features

- Pure sine wave inverter
- Configurable input voltage range for home appliances and personal computers via LCD setting
- Configurable battery charging current based on applications via LCD setting
- Configurable AC/Solar Charger priority via LCD setting
- Compatible to mains voltage or generator power
- Auto restart while AC is recovering
- Overload/ Over temperature/ short circuit protection
- Smart battery charger design for optimized battery performance
- Cold start function

## Basic System Architecture

The following illustration shows basic application for this inverter/charger. It also includes following devices to have a complete running system:

- Generator or Utility.
- PV modules (option)

Consult with your system integrator for other possible system architectures depending on your requirements.

This inverter can power all kinds of appliances in home or office environment, including motor-type appliances such as tube light, fan, refrigerator and air conditioner.

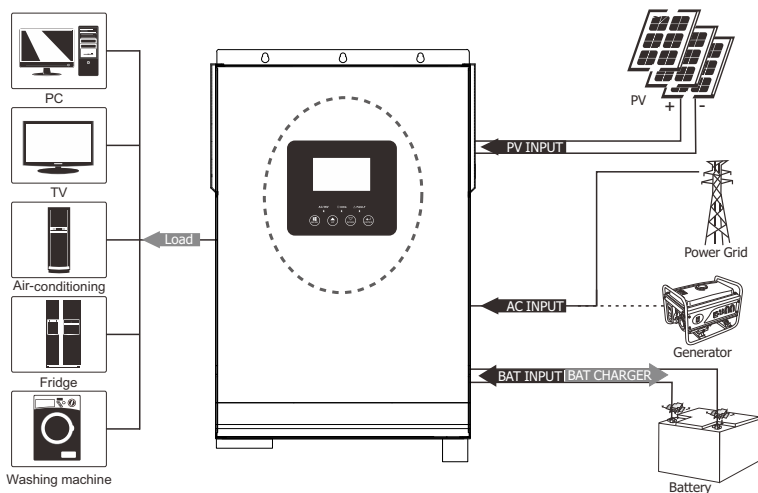
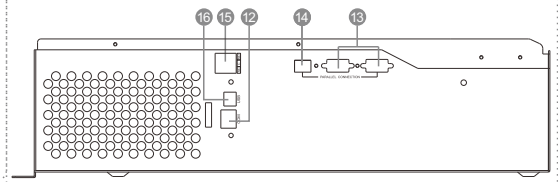
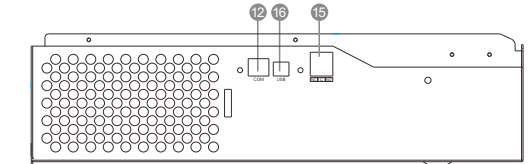
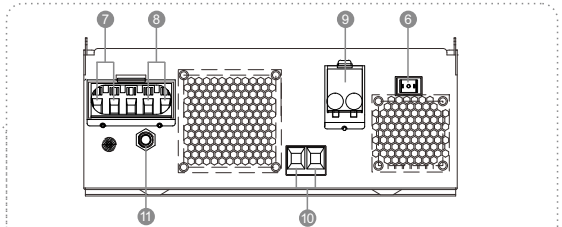
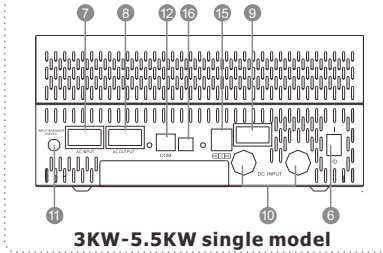
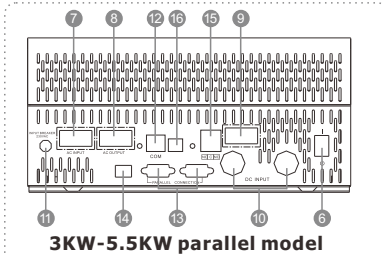
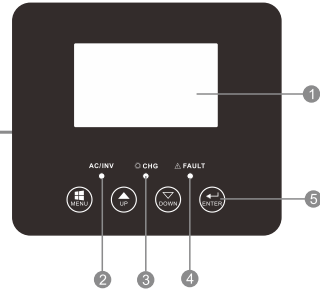
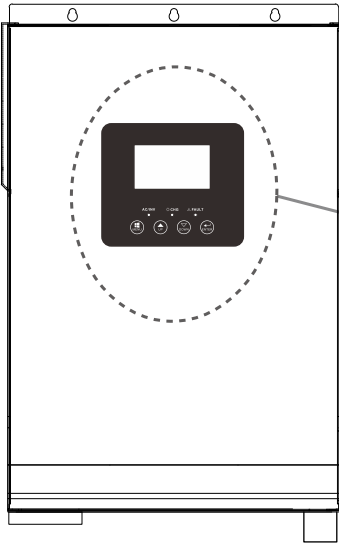

Figure 1 Hybrid Power System

# Product Overview



- |   |                        |                       |                              |
|---|------------------------|-----------------------|------------------------------|
| 1. LCD display  | 2. Status indicator    | 3. Charging indicator | 4. Fault indicator           |
| 5. Function buttons                                       | 6. Power on/off switch | 7. AC input           | 8. AC output                 |
| 9. PV input   | 10. Battery input      | 11. Circuit breaker   | 12. RS485 communication port |
| 13. Parallel communication port (only for parallel model) | 14. Parallel switch    | 15. Dry contact       |                              |
|   | 16. USB                |                       |                              |

## INSTALLATION

### Unpacking and Inspection

Before installation, please inspect the unit. Be sure that nothing inside the package is damaged. You should have received the following items inside of package:

- The unit x 1
- User manual x 1
- USB cable x 1

### Preparation

Before connecting all wirings, please take off bottom cover by removing two screws as shown below.

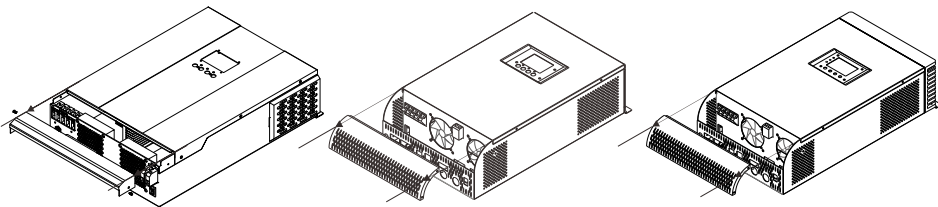

### Mounting the Unit

Consider the following points before selecting where to install:

- Do not mount the inverter on flammable construction materials.
- Mount on a solid surface.
- Install this inverter at eye level in order to allow the LCD display to be read at all times.
- For proper air circulation to dissipate heat, allow a clearance of approx. 200 mm to the side and approx. 300 mm above and below the unit.
- The ambient temperature should be between 0°C and 55°C to ensure optimal operation.
- The recommended installation position is to be adhered to the wall vertically.
- Be sure to keep other objects and surfaces as shown in the diagram to guarantee sufficient heat dissipation and to have enough space for removing wires

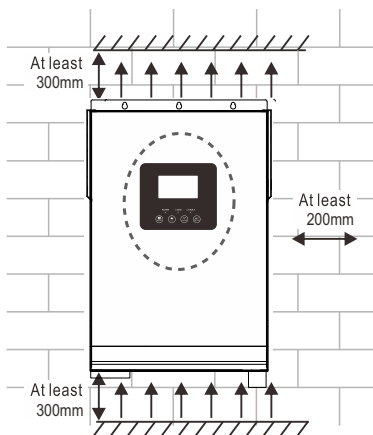

**SUITABLE FOR MOUNTING ON CONCRETE OR OTHER  
NON-COMBUSTIBLE SURFACE ONLY.**

Install the unit by screwing three screws

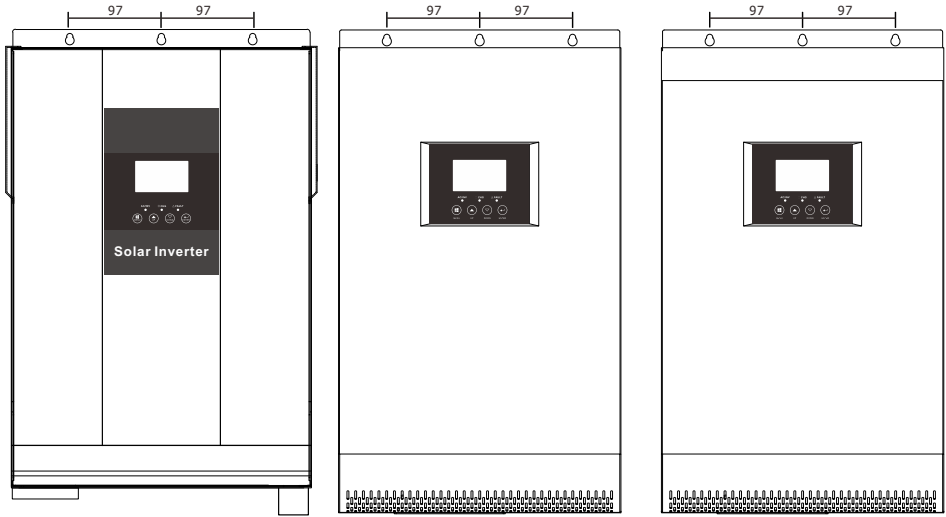

### Battery Connection

**CAUTION:** For safety operation and regulation compliance, it's requested to install a separate DC over-current protector or disconnect device between battery and inverter. It may not be requested to have a disconnect device in some applications, however, it's still requested to have over-current protection installed. Please refer to typical amperage in below table as required fuse or breaker size.

**WARNING!** All wiring must be performed by a qualified personnel.

**WARNING!** It's very important for system safety and efficient operation to use appropriate cable for battery connection. To reduce risk of injury, please use the proper recommended cable and terminal size as below.

#### Recommended battery cable and terminal size:

Model	Typical Amperage	Battery Capacity	Torque Value
2KW DC24V	84A	100AH	1*4AWG
		200AH	2*6AWG
3KW DC24V	125A	100AH	1*4AWG
		200AH	2*6AWG
3KW DC48V	63A	200AH	1*4AWG
			2*6AWG
4KW DC48V	84A	200AH	1*4AWG
			2*6AWG
5KW DC48V	105A	200AH	1*4AWG
			2*6AWG
5.5KW DC48V	115A	200AH	1*4AWG
			2*6AWG

Please follow below steps to implement battery connection:

1. Assemble battery ring terminal based on recommended battery cable and terminal size.
2. Connect all battery packs as units requires. It's suggested to connect at least 200Ah capacity battery for 3KW~5KW model.; at least 100Ah capacity battery for 2KW~3KW.

#### Ring terminal:

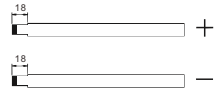

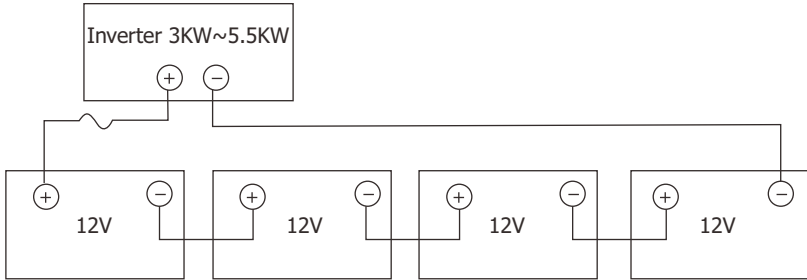
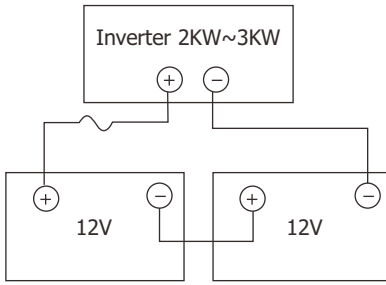

3. Insert the ring terminal of battery cable flatly into battery connector of inverter and make sure the bolts are tightened with torque of 2-3 Nm. Make sure polarity at both the battery and the inverter/charge is correctly connected and ring terminals are tightly screwed to the battery terminals.

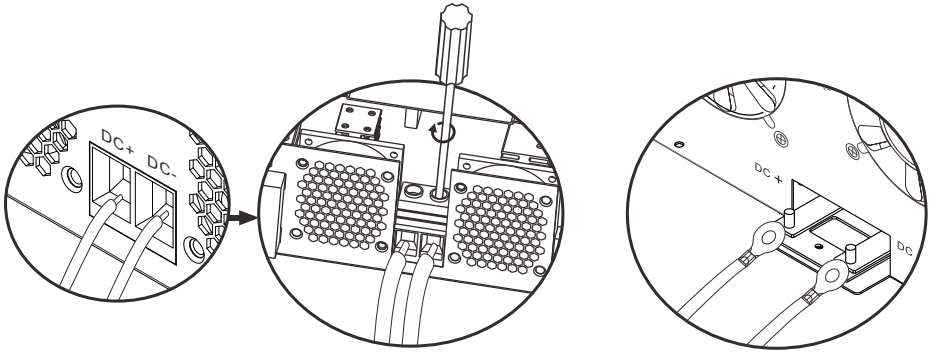

**!** **WARNING: Shock Hazard**  
Installation must be performed with care due to high battery voltage in series.

**!** **CAUTION!!** Do not place anything between the flat part of the inverter terminal and the ring terminal. Otherwise, overheating may occur.  
**CAUTION!!** Do not apply anti-oxidant substance on the terminals before terminals are connected tightly.  
**CAUTION!!!** Before making the final DC connection or closing DC breaker/disconnector, be sure positive (+) must be connected to positive (+) and negative (-) must be connected to negative (-).



## AC Input/Output Connection

**CAUTION!!** Before connecting to AC input power source, please install a separate AC breaker between inverter and AC input power source. This will ensure the inverter can be securely disconnected during maintenance and fully protected from over current of AC input. The recommended spec of AC breaker is 32A for 3KW, 40A for 4KW and 50A for 5-5.5KW.

**CAUTION!!** There are two terminal blocks with "IN" and "OUT" markings. Please do NOT-misconnect input and output connectors.

**WARNING!** All wiring must be performed by a qualified personnel.

**WARNING!** It's very important for system safety and efficient operation to use appropriate cable for AC input connection. To reduce risk of injury, please use the proper recommended cable size as below.

### Suggested cable requirement for AC wires

Model	Gauge	Torque Value
2KW DC24V	14 AWG	0.8~ 1.0Nm
3KW DC24V	10 AWG	1.2~ 1.6Nm
3KW DC48V	12 AWG	1.2~ 1.6Nm
4KW DC48V	10 AWG	1.4~ 1.6Nm
5-5.5KW DC48V	8 AWG	1.4~ 1.6Nm

Please follow below steps to implement AC input/output connection:

1. Before making AC input/output connection, be sure to open DC protector or disconnector first.
2. Remove insulation sleeve 10mm for six conductors. And shorten phase L and neutral conductor N 3mm.
3. Insert AC input wires according to polarities indicated on terminal block and tighten the terminal screws. Be sure to connect PE protective conductor (⊕) first.

⊕ → **Ground (yellow-green)**

L → **LINE (brown or black)**

N → **Neutral (blue)**

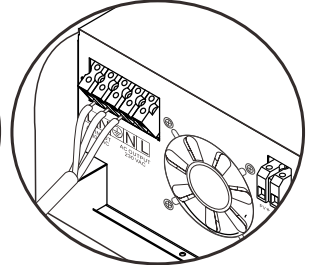
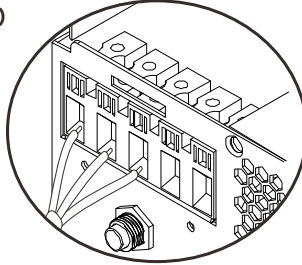

#### **WARNING:**

Be sure to that AC power source is disconnected before attempting to hardwire it to the unit.

4. Then, insert AC output wires according to polarities indicated on terminal block and tighten terminal screws. Be sure to connect PE protective conductor (⊕) first.

⊕ → **Ground (yellow-green)**

L → **LINE (brown or black)**

N → **Neutral (blue)**

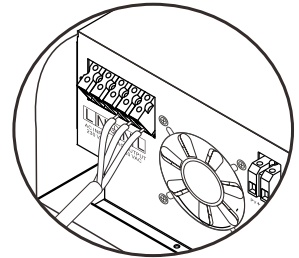
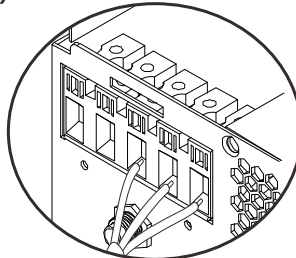

5. Make sure the wires are securely connected.

**CAUTION: Important**

Be sure to connect AC wires with correct polarity. If L and N wires are connected reversely, it may cause utility short-circuited when these inverters are worked in parallel operation.

**CAUTION:** Appliances such as air conditioner are required at least 2~3 minutes to restart because it's required to have enough time to balance refrigerant gas inside of circuits. If a power shortage occurs and recovers in a short time, it will cause damage to your connected appliances. To prevent this kind of damage, please check manufacturer of air conditioner if it's equipped with time-delay function before installation. Otherwise, this inverter/charger will trig overload fault and cut off output to protect your appliance but sometimes it still causes internal damage to the air conditioner.

**PV Connection**

**CAUTION:** Before connecting to PV modules, please install separately a DC circuit breaker between inverter and PV modules.

**WARNING!** All wiring must be performed by a qualified personnel.

**WARNING!** It's very important for system safety and efficient operation to use appropriate cable for PV module connection. To reduce risk of injury, please use the proper recommended cable size as below.

Model	Typical Amperage	Cable Size	Torque
2KW~3KW DC24V	60A/80A	8AWG	1.4~1.6 Nm
3KW~5.5KW DC48V	80A	6AWG	2.0~2.4 Nm

**PV Module Selection:**

When selecting proper PV modules, please be sure to consider below parameters:

1. Open circuit Voltage (Voc) of PV modules not exceeds max. PV array open circuit voltage of inverter.
2. Open circuit Voltage (Voc) of PV modules should be higher than min. battery voltage.
3. Max. Power Voltage (Vmpp) of PV modules should be close to best Vmp of inverter or within Vmp range to get best performance. If one PV module can not meet this requirement, it's necessary to have several PV modules in series connection. Refer to below table.

Note:\* Vmp: panel max power point voltage.

The PV charging efficiency is maximized while PV system voltage is close to Best Vmp.

Maximum PV module numbers in Series: Vmpp of PV module\*X pcs = Best Vmp of Inverter or Vmp range

PV module numbers in Parallel: Max. charging current of inverter/Impp

Total PV module numbers=maximum PV module numbers in series\*PV module numbers in parallel

**Solar Charging Mode**

INVERTER MODEL	2KW~3KW DC24V	3KW~5.5KW DC48V
<b>Rated Power</b>	1500W 2000W	3000W 4000W 5000W
<b>MPPT charger</b>		
solar charging current	60A 80A 100A	
Max. PV Array Open Circuit Voltage	145Vdc	
PV Array MPPT Voltage Range	30~130Vdc	60~130Vdc
Min. battery voltage for PV charge	17Vdc	34Vdc
<b>PWM charger</b>		
solar charging current	60A	
Operating Voltage Range	64~72Vdc	
Max. PV Array Open Circuit Voltage	105Vdc	

## Recommended PV module configuration

<b>Maximum Power (PmaxI)</b>	250W	Max. PV module numbers in series 2→30.9 x 2 =56~72
<b>Max. Power Voltage Vmpp(V)</b>	30.9V	
<b>Max. Power Current Impp(A)</b>	8.42A	PV module numbers in parallel 8→ 60 A/8.42 Total PV module numbers 2x8=16
<b>Open Circuit Voltage Voc(V)</b>	37.7V	
<b>Short Circuit Current Isc(A)</b>	8.89A	

## Solar panel installation schematic

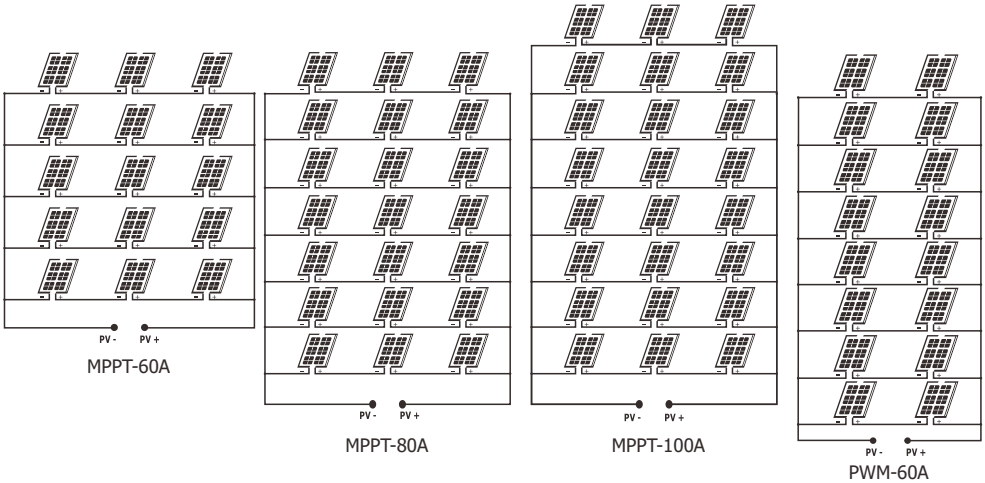

Please follow below steps to implement PV module connection:

1. Remove insulation sleeve 10 mm for positive and negative conductors
2. Check correct polarity of connection cable from PV modules and PV input connectors. Then, connect positive pole (+) of connection cable to positive pole (+) of PV input connector. Connect negative pole (-) of connection cable to negative pole (-) of PV input connector.

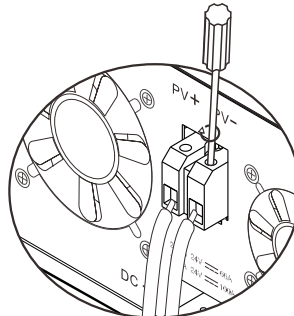
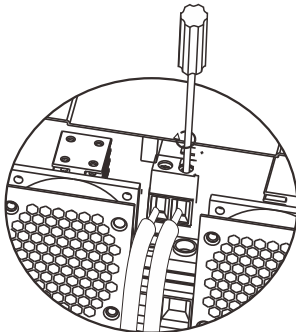
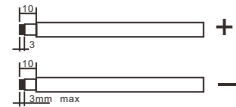

3. Make sure the wires are securely connected.

## Final Assembly

After connecting all wirings, please put bottom cover back by screwing two screws as shown below.

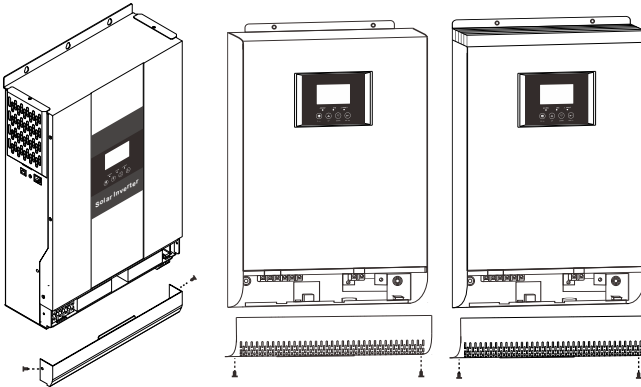

## Communication Connection

Please use supplied communication cable to inverter and PC. Download the software by link on the last page of this manual into computer and follow on screen instruction to install the monitoring software.  
For the detailed software operation, please consult the seller if you have any questions.

**WARNING:** It's forbidden to use network cable as the communication cable to directly communicate with the PC port. Otherwise, the internal components of the controller will be damaged.

**WARNING:** RJ45 interface is only suitable for the use of the company's supporting products or professional operation.

Below chart show RJ45 Pins definition

Pin	Define
1	RS-485-B
2	RS-485-A
3	GND
4	
5	CANL
6	CANH
7	
8	

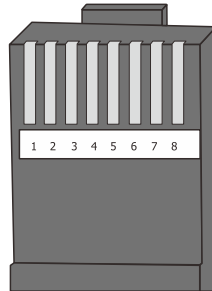

## Dry Contact Signal

There is one dry contact (3A/250VAC) available on the rear panel. It could be used to deliver signal to external device when battery voltage reaches warning level.

Unit status	Condition		Dry contact port:		
			NC&C	NO&C	
Power Off	Unit is off and no output is powered. output is powered from Utility		Close	Open	
			Close	Open	
Power On	Output is powered from Battery or Solar.	Program 01 set as utility	Battery voltage < Low DC warning voltage	Open	Close
			Battery voltage > Setting value in Program 21 or battery charging reaches floating stage	Close	Open
	Program 01 is set as SBU, SUB, solar first		Battery voltage < Setting value in Program 20	Open	Close
			Battery voltage > Setting value in Program 21 or battery charging reaches floating stage	Close	Open

## OPERATION

### Power ON/OFF

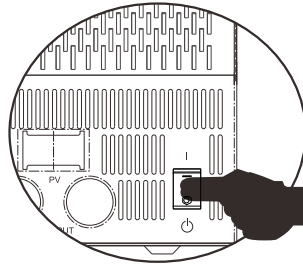
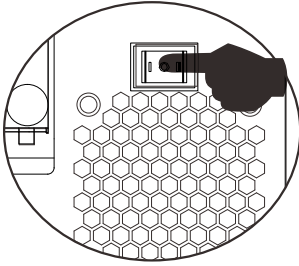

Once the unit has been properly installed and the batteries are connected well, simply press On/Off switch (located on the button of the case) to turn on the unit.

### Operation and Display Panel

The operation and display panel, shown in below chart, is on the front panel of the inverter. It includes three indicators, four function keys and a LCD display, indicating the operating status and input/output power information.

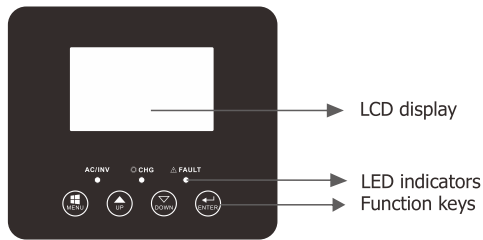

### LED Indicator

LED Indicator		Messages	
AC/ INV	Green	Solid On	Output is powered by grid in Line mode.
		Flashing	Output is powered by battery or PV in battery mode.
CHG	Yellow	Flashing	Battery is charging or discharging.
FAULT	Red	Solid On	Fault occurs in the inverter.
		Flashing	Warning condition occurs in the inverter.

### Function Keys

Function Keys	Description
MENU	Enter reset mode or setting mode go to previous selection.
UP	Increase the setting data.
DOWN	Decrease the setting data.
ENTER	Enter setting mode and Confirm the selection in setting mode go to next selection or exit the reset mode.

## LCD Display Icons

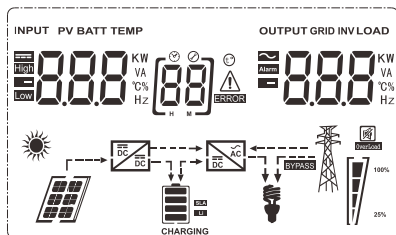



Icon	Function description														
<b>Input Source Information and Output Information</b>															
	Indicates the AC information														
	Indicates the DC information														
	Indicate input voltage, input frequency, PV voltage, battery voltage and charger current. Indicate output voltage, output frequency, load in VA, load in Watt and discharging current.														
<b>Configuration Program and Fault Information</b>															
	Indicates the setting programs														
	Indicates the warning and fault codes. Warning:  flashing with warning code. Fault:  lighting with fault code.														
<b>Battery Information</b>															
	Indicates battery level by 0-24%, 25-49%, 50-74% and 75-100% in battery mode and charging status in line mode.														
In AC mode, it will present battery charging status.															
<table border="1"> <thead> <tr> <th>Status</th> <th>Battery voltage</th> <th>LCD Display</th> </tr> </thead> <tbody> <tr> <td rowspan="4">Constant Current mode/Constant Voltage mode</td> <td>&lt;2V/cell</td> <td>4 bars will flash in turns</td> </tr> <tr> <td>2v/cell~2.083v/cell</td> <td>Bottom bar will be on and the other three bars will flash in turns.</td> </tr> <tr> <td>2.083v/cell~2.167v/cell</td> <td>Bottom two bars will be on and the other two bars will flash in turns.</td> </tr> <tr> <td>&gt;2.167V/cell</td> <td>Bottom three bars will be on and the top bar will flash.</td> </tr> <tr> <td colspan="2">Batteries are fully charged.</td> <td>4 bars will be on.</td> </tr> </tbody> </table>	Status	Battery voltage	LCD Display	Constant Current mode/Constant Voltage mode	<2V/cell	4 bars will flash in turns	2v/cell~2.083v/cell	Bottom bar will be on and the other three bars will flash in turns.	2.083v/cell~2.167v/cell	Bottom two bars will be on and the other two bars will flash in turns.	>2.167V/cell	Bottom three bars will be on and the top bar will flash.	Batteries are fully charged.		4 bars will be on.
Status	Battery voltage	LCD Display													
Constant Current mode/Constant Voltage mode	<2V/cell	4 bars will flash in turns													
	2v/cell~2.083v/cell	Bottom bar will be on and the other three bars will flash in turns.													
	2.083v/cell~2.167v/cell	Bottom two bars will be on and the other two bars will flash in turns.													
	>2.167V/cell	Bottom three bars will be on and the top bar will flash.													
Batteries are fully charged.		4 bars will be on.													

In battery mode, it will present battery capacity.				
Load Percentage	Battery Voltage		LCD Display	
Load > 50%	<1.717V/cell			
	1.717V/cell~1.8V/cell			
	1.8V/cell~1.883V/cell			
	>1.883 V/cell			
50%> Load>20%	<1.817V/cell			
	1.817V/cell~1.9V/cell			
	1.9 V/cell ~1.983V/cell			
	>1.983 V/cell			
Load<20%	<1.867V/cell			
	1.867V/cell~1.95V/cell			
	1.95V/cell~2.033V/cell			
	>2.033 V/cell			
<b>Load Information</b>				
	Indicates overload.			
	Indicates the load level by 0-24%, 25-49%, 50-74% and 75-100%.			
	0%~24%	25%~49%	50%~74%	75%~100%
<b>Mode Operation Information</b>				
	Indicates unit connects to the mains.			
	Indicates unit connects to the PV panel.			
	Indicates load is supplied by utility power.			
	Indicates the solar charger circuit is working.			
	Indicates the DC/AC inverter circuit is working.			
<b>Mute Operation</b>				
	Indicates unit alarm is disabled.			

### LCD Setting

After pressing and holding "ENTER" button for 2 seconds, the unit will enter setting mode. Press "UP" or "DOWN" button to select setting programs. And then, press "ENTER" or "MENU" button to confirm the selection and exit.

### Setting Programs:

Program	Description	Selectable option	
00	Exit setting mode	Escape 	
01	Output source priority selection	(default) 	Solar energy provides power to the loads as first priority, If solar energy is not sufficient to power all connected loads, Utility energy will supply power to the loads at the same time. The battery energy will supply power to the load only in the condition of the utility is unavailable. If the solar is unavailable, the utility will charge the battery until the battery voltage reaches the setting point in program 21.If the solar is available, but the voltage is lower than the setting point in program 20, the utility will charge the battery until the battery voltage reaches the setting point in program 20 to protect the battery from damage.
			Solar energy provides power to the loads as first priority, If solar energy is not sufficient to power all connected loads, battery energy will supply power to the loads at the same time. Utility provides power to the loads only when battery voltage drops to either low-level warning voltage or the setting point in program 20 or solar and battery is not sufficient. The battery energy will supply power to the load in the condition of the utility is unavailable or the battery voltage is higher than the setting point in program 21(when BLU is selected) or program 20(when LBU is selected). If the solar is available, but the voltage is lower than the setting point in program 20, the utility will charge the battery until the battery voltage reaches the setting point in program 20 to protect the battery from damage.



		[0] SOL	<p>Solar energy provides power to the loads as first priority.</p> <p>If battery voltage has been higher than the setting point in program 21 for 5 minutes, and the solar energy has been available for 5 minutes too, the inverter will turn to battery mode, solar and battery will provide power to the loads at the same time.</p> <p>When the battery voltage drops to the setting point in program 20, the inverter will turn to bypass mode, utility provides power to the load only, and the solar will charge the battery at the same time.</p>
		[0] UT,	<p>Utility will provide power to the loads as first priority. Solar and battery energy will provide power to the loads only when utility power is not available.</p>
02	AC input voltage range	Appliances (default) [02] APPL	If selected, acceptable AC input voltage range will be within 90-280VAC.
		UPS [02] UPS	If selected, acceptable AC input voltage range will be within 170-280VAC.
		GEN [02] GEN	When the user uses the device to connect the generator, select the generator mode.
		VDE [02] VDE	If selected, acceptable AC input voltage range will conform to VDE4105 (184VAC-253VAC)
03	Output voltage	[03] 230 <sub>v</sub>	Set the output voltage amplitude, (220VAC-240VAC)
04	Output frequency	50HZ(default) [04] 500 <sub>Hz</sub>	60HZ [04] 600 <sub>Hz</sub>
05	Solar supply priorit	(default) [05] BLU	<p>Solar energy provides power to charge battery as first priority.</p> <p>When the utility is available, if the battery voltage is lower than the setting point in program 21, the solar energy will never supply to the load, only charge the battery. If the battery voltage is higher than the setting point in program 21, the solar energy will supply to the load or recharge the battery.</p>

		[05] LBU	Solar energy provides power to the loads as first priority. If the battery voltage is lower than the setting point in program 20, the solar energy will never supply to the load, only charge the battery. If the battery voltage is higher than the setting point in program 20, the solar energy will supply to the load or recharge the battery.
06	Overload bypass: When enabled, the unit will transfer to line mode if overload occurs in battery mode.	Bypass disable [06] bYd	Bypass enable(default) [06] bYE
07	Auto restart when overload occurs	Restart disable(default) [07] Lfd	Restart enable [07] LfE
08	Auto restart when over temperature occurs	Restart disable(default) [08] tfd	Restart enable [08] tFE
10	Charger source priority: To configure charger source priority	If this inverter/charger is working in Line, Standby or Fault mode, charger source can be programmed as below:	
		Solar first [10] C50	Solar energy will charge battery as first priority. Utility will charge battery only when solar energy is not available.
		Solar and Utility(default) [10] 5nU	Solar energy and utility will charge battery at the same time.
		Only Solar [10] 050	Solar energy will be the only charger source no matter utility is available or not
If this inverter/charger is working in Battery mode, only solar energy can charge battery. Solar energy will charge battery if it's available and sufficient.			
11	Maximum charging current: To configure total charging current for solar and utility chargers.(Max. charging current =utility charging current + solar charging current)	60A (default) [1] 60 <sup>A</sup>	Setting range is from 1 A to 120A. Increment of each click is 1A.
		80A (default) [1] 80 <sup>A</sup>	Setting range is from 1 A to 140A. Increment of each click is 1A.
		100A (default) [1] 100 <sup>A</sup>	Setting range is from 1 A to 160A. Increment of each click is 1A.
13	Maximum utility charging current	30A (default) [13] 30 <sup>A</sup>	Setting range is from 1A to 60A. Increment of each click is 1A.

14	Battery type	AGM (default) [14]AGM	Flooded [14]FLD
		GEL [14]GEL	LEAD [14]LEA
		Lithium Ion [14]LI	User-Defined [14]USE
		If "User-Defined" LI is selected, battery charge voltage and low DC cut-off voltage can be set up in program 17, 18 and 19.	
17	Bulk charging voltage (C.V voltage)	24V model default setting: 28.2V [17]CV 28.2 <sup>v</sup>	
		If "User-Defined" LI is selected in program 14, this program can be set up. Setting range is from 24.0V to 29.2V for 24Vdc model. Increment of each click is 0.1V.	
		48V model default setting: 56.4V [17]CV 56.4 <sup>v</sup>	
		If "User-Defined" LI is selected in program 14, this program can be set up. Setting range is from 48.0V to 58.4V for 48Vdc model. Increment of each click is 0.1V.	
18	Floating charging voltage	24V model default setting: 27.0V [18]FLV 27.0 <sup>v</sup>	
		If "User-Defined" LI is selected in program 14, this program can be set up, Setting range is from 24.0V to 29.2V for 24Vdc model. Increment of each click is 0.1V.	
		48V model default setting: 54.0V [18]FLV 54.0 <sup>v</sup>	
		If "User-Defined" LI is selected in program 14, this program can be set up, Setting range is from 48.0V to 58.4V for 48Vdc model. Increment of each click is 0.1V.	
19	Low DC cut off battery voltage setting	24V model default setting: 20.4V [19]COV 20.4 <sup>v</sup>	
		If "User-Defined" LI is selected in program 14, this program can be set up. Setting range is from 20.0V to 24.0V for 24Vdc model. Increment of each click is 0.1V. Low DC cut-off voltage will be fixed to setting value no matter what percentage of load is connected.	
		48V model default setting: 40.8V [19]COV 40.8 <sup>v</sup>	
		If "User-Defined" LI is selected in program 14, this program can be set up. Setting range is from 40.0V to 48.0V for 48Vdc model. Increment of each click is 0.1V. Low DC cut-off voltage will be fixed to setting value no matter what percentage of load is connected.	

20	Battery stop discharging voltage when grid is available	Available options for 24V models:	
		23.0V (default) [20] 230 <sub>v</sub>	Setting range is from 22.0V to 29.0V. Increment of each click is 0.1V.
		Available options for 48V models:	
		46.0V (default) [20] 460 <sub>v</sub>	Setting range is from 44.0V to 58.0V. Increment of each click is 0.1V.
21	Battery stop charging voltage when grid is available	Available options for 24V models:	
		27.0V (default) [21] 270 <sub>v</sub>	Setting range is from 22.0V to 29.0V. Increment of each click is 0.1V.
		Available options for 48V models:	
		54.0V (default) [21] 540 <sub>v</sub>	Setting range is from 44.0V to 58.0V. Increment of each click is 0.1V.
22	Auto turn page	(default) [22] PLE	If selected, the display screen will auto turn the display page.
		[22] PLEd	If selected, the display screen will stay at latest screen user finally switches.
23	Backlight control	Backlight on [23] LON	Backlight off (default) [23] LOF
24	Alarm control	Alarm on (default) [24] 6ON	Alarm off [24] 6OF
25	Beeps while primary source is interrupted	Alarm on [25] AON	Alarm off (default) [25] AOF
27	Record Fault code	Record enable(default) [27] FON	Record disable [27] FOF
28	Solar power balance: When enabled, solar input power will be automatically adjusted according to connected load power.	Solar power balance enable [28] 56E	If selected, the solar input power will be automatically adjusted according to the following formula: Max. Input solar power = Max.battery charging power + Connected load power when the machine in OffGrid workstate.
		Solar power balance disable (default) [28] 56d	If selected, the solar input power will be the same to max. Battery charging power no matter how much loads are connected. The max.battery charging power will be based on the setting current in program 11 ( Max. solar power = Max.battery charging power )













29	Power saving mode enable/ disable	Saving mode disable (default) [29] 5d5	If disable, no matter connected load is low or high, the on/off status of inverter output will not be effected.
		Saving mode enable [29] 5eN	If enable, the output of inverter will be off when connected load is pretty low or not detected.
30	Battery equalization	Battery equalization [30] EeN	Battery equalization disable(default) [30] Ed5
31	Battery equalization voltage	Available options for 24V models:28.8V [31] E <sup>v</sup> 288 <sup>v</sup>	
		Available options for 48V models:57.6V [31] E <sup>v</sup> 576 <sup>v</sup>	
		Setting range is from 24.0V to 29.2V for 24V model and 48.0V to 58.4V for 48V model. Increment of each click is 0.1V.	
33	Battery equalization time	60min(default) [33] 60	Setting range is from 5 min to 900min. Increment of each click is 5min.
34	Battery equalization timeout	120min(default) [34] 120	Setting range is from 5 min to 900min. Increment of each click is 5min.
35	Equalization interval	30days(default) [35] 30d	Setting range is from 0 to 90days. Increment of each click is 1 day.
36	Equalization activated immediately	Enable [36] AeN	Disable(default) [36] Ad5
		If equalization function is enabled in program 30, this program can be set up. If "Enable" is selected in this program, it's to activate battery equalization immediately and LCD main page will show "E <sup>v</sup> ". If "Disable" is selected, it will cancel equalization function until next activated equalization time arrives based on program 35 setting. At this time, "E <sup>v</sup> " will be shown in LCD main page too.	
37	BMS control method	Voltage method(default) [37] 40L	SOC Percent method [37] 50C
38	Battery stop discharging percent When SOC is available	20 % (default) [38] 20 %	Setting range is from 20 % to 100 % Increment of each click is 1 % .
39	Battery stop charging percent When SOC is available	95 % (default) [39] 95 %	Setting range is from 20 % to 100 % Increment of each click is 1 % .



















40	BMS communication	(default) [40] 1dP	when the communication between BMS and converter is faulted ,the converter still charge or discharge from the battery
		[40] U n1	when the communication between BMS and converter is faulted ,the converter stop charging or discharging from the battery

After pressing and holding "MENU" button for 6 seconds, the unit will enter reset model. Press "UP" and "DOWN" button to select programs. And then, press "ENTER" button to exit.













SET	(default) [dt] nft	Reset setting disable
	[dt] tSt	Reset setting enable

### Fault Reference Code

Fault Code	Fault Cause	LCD Indication
01	Fan is locked when inverter is off	[01] 
02	Inverter transformer over temperature	[02] 
03	Battery voltage is too high	[03] 
04	Battery voltage is too low	[04] 
05	Output short circuited	[05] 
06	Inverter output voltage is high	[06] 
07	Overload time out	[07] 
08	Inverter bus voltage is too high	[08] 
09	Bus soft start failed	[09] 
11	Main relay failed	[11] 
21	Inverter output voltage sensor error	[21] 
22	Inverter grid voltage sensor error	[22] 
23	Inverter output current sensor error	[23] 







24	Inverter grid current sensor error	[24]  ERROR
25	Inverter load current sensor error	[25]  ERROR
26	Inverter grid over current error	[26]  ERROR
27	Inverter radiator over temperature	[27]  ERROR
31	Solar charger battery voltage class error	[31]  ERROR
32	Solar charger current sensor error	[32]  ERROR
33	Solar charger current is uncontrollable	[33]  ERROR
41	Inverter grid voltage is low	[41]  ERROR
42	Inverter grid voltage is high	[42]  ERROR
43	Inverter grid under frequency	[43]  ERROR
44	Inverter grid over frequency	[44]  ERROR
51	Inverter over current protection error	[51]  ERROR
52	Inverter bus voltage is too low	[52]  ERROR
53	Inverter soft start failed	[53]  ERROR
55	Over DC voltage in AC output	[55]  ERROR
56	Battery connection is open	[56]  ERROR
57	Inverter control current sensor error	[57]  ERROR
58	Inverter output voltage is too low	[58]  ERROR

## Warning Indicator

Warning Code	Warning Event	Icon flashing
61	Fan is locked when inverter is on.	
62	Fan 2 is locked when inverter is on.	
63	Battery is over-charged.	
64	Low battery	
67	Overload	
70	Output power derating	
72	Solar charger stops due to low battery	
73	Solar charger stops due to high PV voltage	
74	Solar charger stops due to over load	
75	Solar charger over temperature	
76	PV charger communication error	
77	Parameter error	

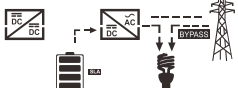
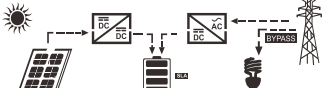

## Operating State Description

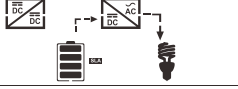
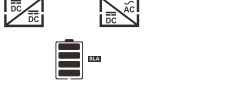
Operating State	Description	LCD display
<p>Match load state</p> <p>Note: DC power produced from your solar array is converted by the inverter into AC power, which is then sent to your main electrical panel to be used by your household appliances. Any excess power generated is not sold back to the grid, but stored in battery.</p>	<p>PV energy is charger into the battery or converted by the inverter to the AC load</p>	<p>PV energy power is larger than inverter power</p> 
	<p>PV energy power is smaller than inverter power</p>	
	<p>PV is off</p>	
<p>Charge state</p>	<p>PV energy and grid can charge batteries.</p>	
<p>Bypass state</p>	<p>Error are caused by inside circuit error or external reasons such as over temperature, output short circuited and so on.</p>	
<p>Off-Grid state</p>	<p>The inverter will provide output power from battery and PV power.</p>	<p>Inverter power loads from PV energy.</p> 
		<p>Inverter power loads from battery and PV energy.</p> 
		<p>Inverter power loads from battery only.</p> 
<p>Stop mode</p>	<p>The inverter stop working if you turn off the inverter by the soft key or error has occurred in the condition of no grid.</p>	

## Display Setting

The LCD display information will be switched in turns by pressing "UP" or "DOWN" key. The selectable information is switched as below order: battery voltage, battery current, inverter voltage, inverter current, grid voltage, grid current, load in Watt, load in VA, grid frequency, inverter frequency, PV voltage, PV charging power, PV charging output voltage, PV charging current.

Selectable information	LCD display	
Battery voltage/DC discharging current	<sup>BATT</sup> 520 <sup>V</sup>	480 <sup>A</sup>
Inverter output voltage/Inverter output current	229 <sup>V</sup>	<sup>INV</sup> 130 <sup>A</sup>
Grid voltage/Grid current	229 <sup>V</sup>	<sup>GRID</sup> 80 <sup>A</sup>
Load in Watt	100 <sup>KW</sup>	<sup>LOAD</sup> 120 <sup>KVA</sup>
Grid frequency/Inverter frequency	<sup>INPUT</sup> 500 <sup>Hz</sup>	<sup>INV</sup> 500 <sup>Hz</sup>
PV voltage and power	<sup>PV</sup> 120 <sup>V</sup>	200 <sup>KW</sup>
PV charger output voltage and PV charging current	<sup>PV</sup> 510 <sup>V</sup>	<sup>OUTPUT</sup> 400 <sup>A</sup>

## SPECIFICATIONS

Table 1 Line Mode Specifications

INVERTER MODEL	2KW~5.5KW
Input Voltage Waveform	Sinusoidal (utility or generator)
Nominal Input Voltage	230Vac
Low Loss Voltage	90Vac±7V(APL,GEN);170Vac±7V(UPS); 186Vac±7V(VDE)
Low Loss Return Voltage	100Vac±7V(APL,GEN);180Vac±7V(UPS); 196Vac±7V(VDE)
High Loss Voltage	280Vac±7V(UPS,APL,GEN); 253Vac±7V(VDE)
High Loss Return Voltage	270Vac±7V(UPS,APL,GEN); 250Vac±7V(VDE)
Max AC Input Voltage	300Vac
Nominal Input Frequency	50HZ/60HZ(Auto detection)
Low Loss Frequency	40HZ±1HZ(UPS,APL,GEN); 47.5HZ±0.05HZ(VDE)
Low Loss Return Frequency	42HZ±1HZ(UPS,APL,GEN); 47.5HZ±0.05HZ(VDE)
High Loss Frequency	65HZ±1HZ(UPS,APL,GEN); 51.5HZ±0.05HZ(VDE)
High Loss Return Frequency	63HZ±1HZ(APL,GEN,UPS); 50.05HZ±0.05HZ(VDE)

<b>Output Short Circuit Protection</b>	Line mode: Circuit Breaker Battery mode: Electronic Circuits
<b>Efficiency (Line Mode)</b>	>95%(Rated R load, battery full charged)
<b>Transfer Time</b>	10ms typical (UPS,VDE) 20ms typical (APL)
<b>Output power derating:</b> When AC input voltage drops to 95V or 170V depending on models, the output power will be derated.	230Vac model: 

Table 2 Inverter Mode Specifications

<b>INVERTER MODEL</b>	<b>2KW~3KW DC24V</b>	<b>3KW~5.5KW DC48V</b>
<b>Rated Output Power</b>	2000W~3000W	3000W~5500W
<b>Output Voltage Waveform</b>	Pure Sine Wave	
<b>Output Voltage Regulation</b>	230Vac±5%	
<b>Output Frequency</b>	60Hz or 50Hz	
<b>Peak Efficiency</b>	90%	
<b>Overload Protection</b>	5s@≥150% load; 10s@110%~150% load	
<b>Surge Capacity</b>	2 x rated power for 5 seconds	
<b>Nominal DC Input Voltage</b>	24Vdc	48Vdc
<b>Cold Start Voltage</b>	23.0Vdc	46.0Vdc
<b>Low DC Warning Voltage</b>		
@ load < 20%	22.0Vdc	44.0Vdc
@ 20% ≤ load < 50%	21.4Vdc	42.8Vdc
@ load ≥ 50%	20.2Vdc	40.4Vdc
<b>Low DC Warning Return Voltage</b>		
@ load < 20%	23.0Vdc	46.0Vdc
@ 20% ≤ load < 50%	22.4Vdc	44.8Vdc
@ load ≥ 50%	21.2Vdc	42.4Vdc

<b>Low DC Cut-off Voltage</b>		
@ load < 20%	21.0Vdc	42.0Vdc
@ 20% ≤ load < 50%	20.4Vdc	40.8Vdc
@ load ≥ 50%	19.2Vdc	38.4Vdc
<b>High DC Recovery Voltage</b>	27Vdc	58Vdc
<b>High DC Cut-off Voltage</b>	30Vdc	60Vdc

Table 3 Charge Mode Specifications

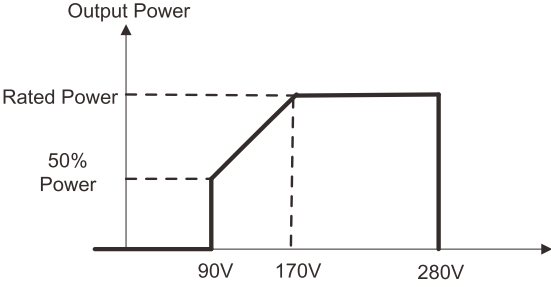
<b>Utility Charging Mode</b>			
<b>INVERTER MODEL</b>		<b>2KW~3KW DC24V</b>	<b>3KW~5.5KW DC48V</b>
<b>Charging Current @ Nominal Input Voltage</b>		1~60A	
<b>Floating charging voltage</b>	<b>AGM / Gel/LEAD Battery</b>	27.4Vdc	54.8Vdc
	<b>Flooded battery</b>	27.4Vdc	54.8Vdc
<b>Bulk charging voltage (C.V voltage)</b>	<b>AGM / Gel/LEAD Battery</b>	28.8Vdc	57.6Vdc
	<b>Flooded battery</b>	28.4Vdc	56.8Vdc
<b>Charging Algorithm</b>		3-Step(Flooded Battery,AGM/Gel/LEAD Battery),4-Step(LI)	
<b>Solar Charging Mode</b>			
<b>INVERTER MODEL</b>		<b>2KW~3KW DC24V</b>	<b>3KW~5.5KW DC48V</b>
<b>Rated Power</b>		1500W 2000W	3000W 4000W 5000W
<b>MPPT charger</b>			
<b>solar charging current</b>		60A 80A 100A	
<b>Max.PV Array Open Circuit Voltage</b>		145Vdc max	
<b>PV Array MPPT Voltage Range</b>		30~130Vdc	60~130Vdc
<b>Min battery voltage for PV charge</b>		17Vdc	34Vdc
<b>Standby Power Consumption</b>		2W	
<b>PWM charger</b>			
<b>solar charging current</b>		60A	
<b>Operating Voltage Range</b>		64~72Vdc	
<b>Max.PV Array Open Circuit Voltage</b>		105Vdc	
<b>Min battery voltage for PV charge</b>		34Vdc	
<b>Battery Voltage Accuracy</b>		+/-0.3%	
<b>PV Voltage Accuracy</b>		+/-2V	
<b>Charging Algorithm</b>		3-Step(Flooded Battery,AGM/Gel/LEAD Battery), 4-Step(LI)	

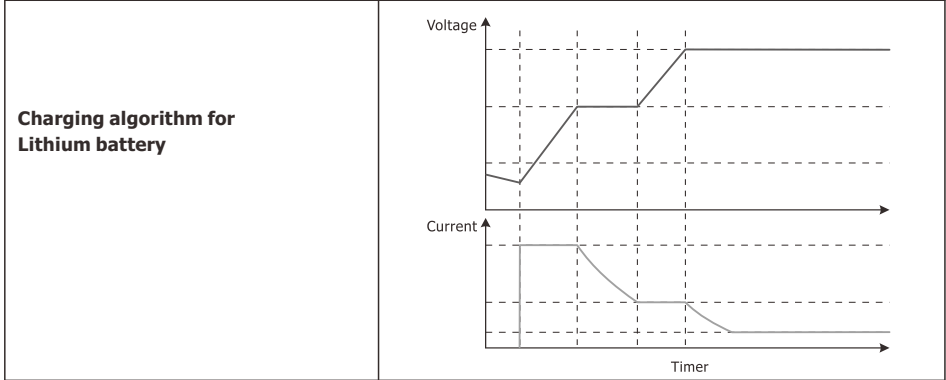
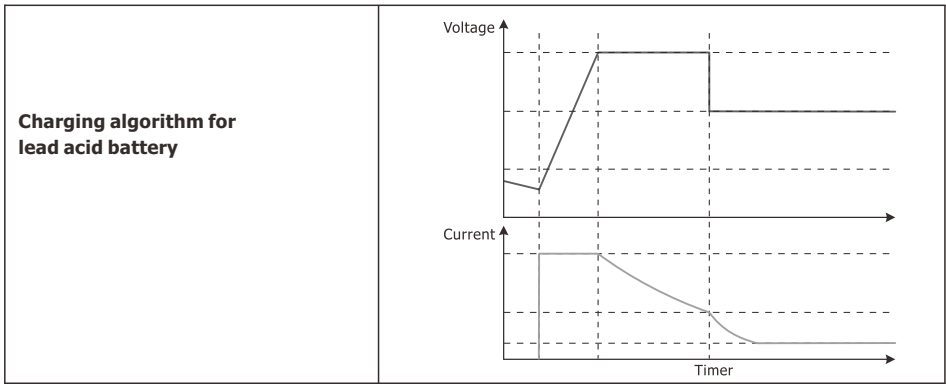

**Joint Utility and Solar Charging**

INVERTER MODEL	2KW~3KW DC24V	3KW~5.5KW DC48V	
	MPPT	MPPT	PWM
Max Charging Current	120A 140A	120A 140A 160A	120A
Default Charging Current	60A 80A	60A 80A 100A	60A

Table 4 General Specifications

INVERTER MODEL	2KW~3KW DC24V	3KW~5.5KW DC48V
Safety Certification	CE	
Operating Temperature Range	-10°C to 50°C	
Storage temperature	-15°C~ 60°C	
Dimension (D*W*H), mm	420 x 288 x 122	468 x 330 x 119
Net Weight, kg	9.0	10.0

## TROUBLE SHOOTING

Problem	LCD/LED/Buzzer	Explanation / Possible cause	What to do
Unit shuts down automatically during startup process.	LCD/LEDs and buzzer will be active for 3 seconds and then complete off.	The battery voltage is too low (< 1.91V/Cell)	1. Re-charge battery. 2. Replace battery.
No response after power on.	No indication.	1. The battery voltage is far too low. (<1.4V/Cell) 2. Battery polarity is connected reversed. Input protector is tripped	1. Check if batteries the wiring are connected and well. 2. Re-charge battery. 3. Replace battery.
Mains exist but the unit works in battery mode.	Input voltage is displayed as 0 on the LCD and green LED is flashing.	Input protector is tripped	Check if AC breaker is tripped and AC wiring is connected well.
	Green LED is flashing.	Insufficient quality of AC power (Shore or Generator)	1. Check if AC wires are too thin and/or too long. 2. Check if generator (if applied) is working well or if input voltage range setting is correct. (Appliance=>wide)
When the unit is turned on, internal relay is switched on and off repeatedly.	LCD display and LEDs are flashing	Battery is disconnected.	Check if battery wires are connected well.
Buzzer beeps continuously and red LED is on.	Fault code 07	Overload error. The inverter is overload 110% and time is up.	Reduce the connected load by switching off some equipment.
	Fault code 05	Output short circuited.	Check if wiring is connected well and remove abnormal load.
	Fault code 02	Internal temperature of inverter component is over 90°C.	Check whether the air flow of the unit is blocked or whether the ambient temperature is too high.
	Fault code 03	Battery is over-charged.	Return to repair center.
		The battery voltage is too high.	Check if spec and quantity of batteries are meet requirements.
	Fault code 01	Fan fault	Fan fault
	Fault code 06/58	Output abnormal (Inverter voltage below than 202Vac or is higher than 253Vac)	1. Reduce the connected load. 2. Return to repair center
	Fault code 08/09/53/57	Internal components filed.	Return to repair center
	Fault code 51	Over current or surge	Restart the unit, if the error happens again, please return to repair center.
	Fault code 52	Bus voltage is too low	
Fault code 55	Output voltage is unbalanced		
Fault code 56	Battery is not connected well or fuse is burnt.	If the battery is connected well, please return to repair center.	

**Appendix: Approximate Back-up Time Table**

Model	Load(W)	Backup Time@24Vdc 100Ah(min)	Backup Time@24Vdc 200Ah(min)
2KW	200	766	1610
	400	355	766
	600	198	503
	800	139	339
	1000	112	269
	1200	95	227
	1400	81	176
	1600	62	140
	1800	55	125
3KW	2000	50	112
	300	449	1100
	600	222	525
	900	124	303
	1200	95	227
	1500	68	164
	1800	56	126
	2100	48	108
	2400	35	94
3KW	2700	31	74
	3000	28	67

Model	Load(W)	Backup Time@48Vdc 100Ah(min)	Backup Time@48Vdc 200Ah(min)
3KW	300	1054	2107
	600	491	1054
	900	291	668
	1200	196	497
	1500	159	402
	1800	123	301
	2100	105	253
	2400	91	219
	2700	71	174
4KW	3000	63	155
	400	766	1610
	800	335	766
	1200	198	503
	1600	139	339
	2000	112	269
	2400	95	227
	2800	81	176
	3200	62	140
5KW	3600	55	125
	4000	50	112
	500	613	1288
	1000	268	613
	1500	158	402
	2000	111	271
	2500	90	215
	3000	76	182
	3500	65	141
5KW	4000	50	112
	4500	44	100
	5000	40	90

**Note:** Backup time depends on the quality of the battery, age of battery and type of battery.  
 Specifications of batteries may vary depending on different manufacturers.

# USER'S MANUAL

## SOLAR INVERTER

Please download the software “SolarPowerMonitor2.2.81”.



China:<https://cn.must-ee.com>



Oversea:<https://en.must-ee.com>